

## ASSEMBLY INSTRUCTIONS

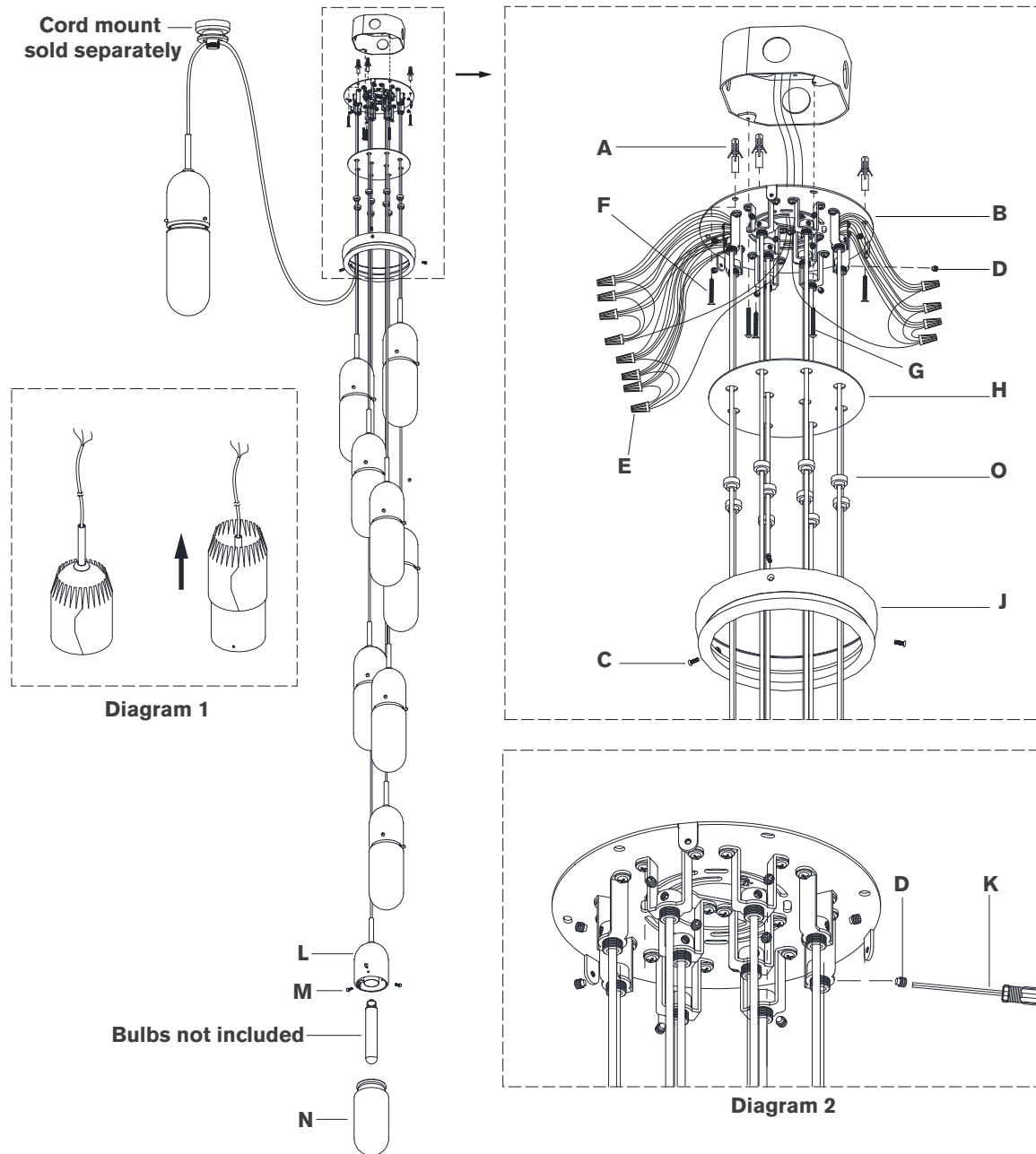

## Junio 10-Light Pendant

Item # TOB5645-10

### NOTICE:

This light fixture should be installed in accordance with all applicable, local installation codes, and by a person familiar with the construction and operation of it, as well as the hazards involved. Inspect item and contents carefully. If any damage or defect is found, do not install. Retain all packaging material until installation is complete and approved.

### TOOLS REQUIRED (NOT INCLUDED):

Phillips Screwdriver	Slotted Screwdriver	Wire Cutters
Wire Strippers	Hammer	Pencil
Drill		

- Carefully remove all parts from the box. Place on a clean, soft surface.
- Remove mounting plate **(B)** from canopy **(J)** by removing screws **(C)**.
- Remove metal plate **(H)** from mounting plate **(B)** by removing collar rings **(O)**.
- Using mounting plate **(B)** as a guide, line up with the junction box and mark anchor positions.
- Using a drill bit slightly smaller than the anchor, drill holes in the marked positions. Install anchors **(A)** into holes using hammer.
- Install mounting plate **(B)** to junction box and secure with mounting screws **(G)**, then secure wood screws **(F)** to anchors **(A)**.
- Feed fixture wires through canopy **(J)**, collar rings **(O)** and metal plate **(H)**.
 

**NOTE:** Slide packaging up cord for light head inspection, then slide back down and leave in place until installation is complete. See diagram 1.
- Insert fixture wires through the center hole of mounting bracket and secure with set screws **(D)** using provided wrench **(K)**. See diagram 2.
 

**NOTE:** Set fixture to desired height before moving to next step.
- Cut excess wires, being sure to leave enough to reach the junction box. Separate wires, and strip insulation on each 5/8".

## ASSEMBLY INSTRUCTIONS

Cord mount  
sold separately

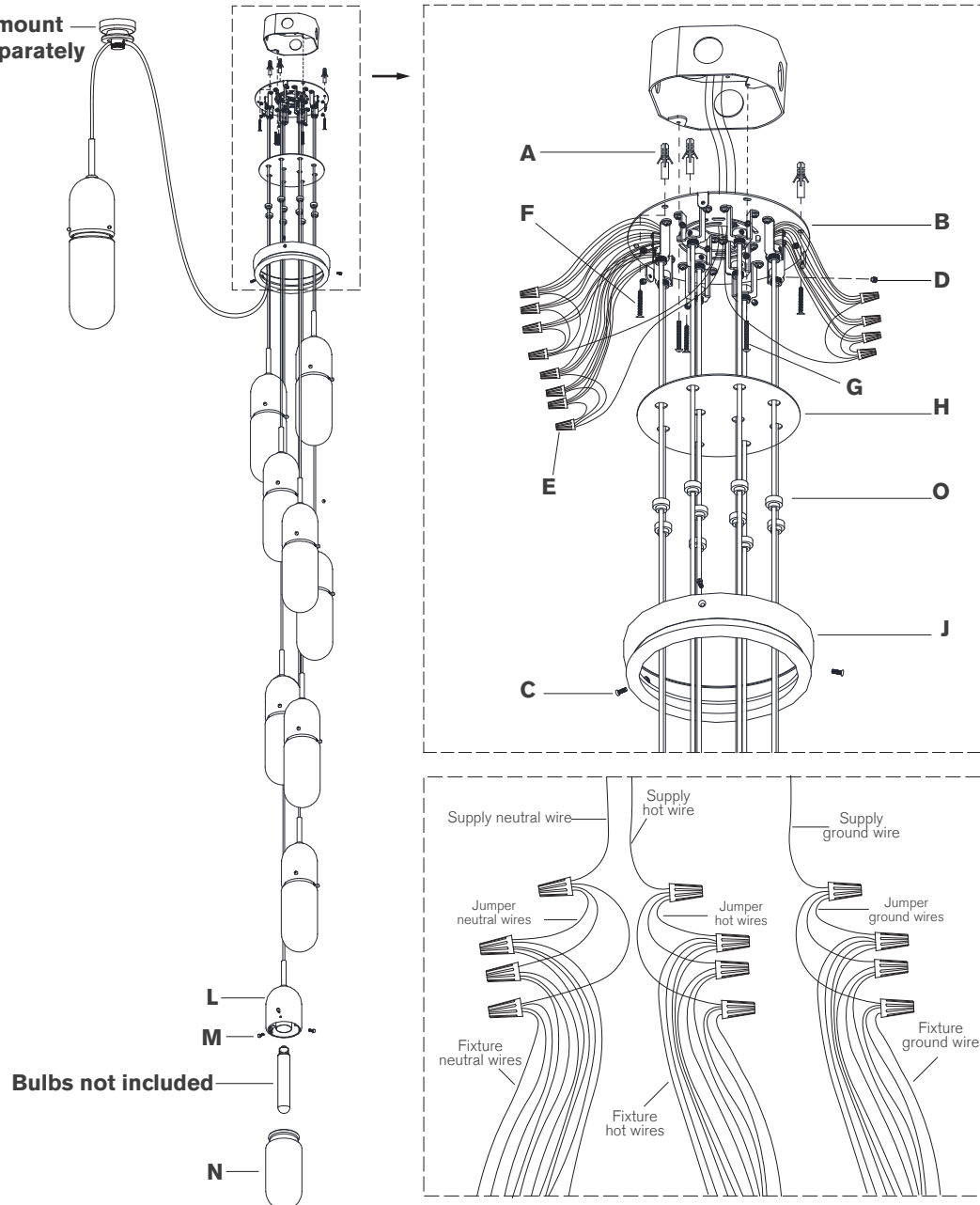

Bulbs not included

Diagram 3

## Junio 10-Light Pendant

Item # TOB5645-10

### NOTICE:

This light fixture should be installed in accordance with all applicable, local installation codes, and by a person familiar with the construction and operation of it, as well as the hazards involved. Inspect item and contents carefully. If any damage or defect is found, do not install. Retain all packaging material until installation is complete and approved.

10. Wrap supply ground wire (bare copper) around the green grounding screw. Tighten. Connect 2 jumper wires to supply ground wire (usually green or bare copper) and secure using wire nut (E). Divide fixture ground wires (green) by section and connect to jumper ground wires, securing with wire nut (E). See diagram 3.

**NOTE:** Divide sections of ground wire evenly to jumper wires as shown in diagram 3

**NOTE:** It is imperative that the fixture is grounded.

11. Connect 2 jumper neutral wires to supply neutral wire (usually white) and secure using wire nut (E). Divide fixture neutral wires (white) by section and connect to jumper neutral wires, securing with wire nut (E). See diagram 3.

**NOTE:** Divide sections of neutral wire evenly to jumper wires as shown in diagram 3.

12. Connect 2 jumper hot wires to supply hot wire (usually black) and secure using wire nut (E). Divide fixture hot wires (black) by section and connect to jumper hot wires, securing with wire nut (E). See diagram 3.

**NOTE:** Divide sections of hot wire evenly to jumper wires as shown in diagram 3.

**CAUTION:** Do not reverse the hot and neutral connections.

13. Install metal plate (H) to mounting plate (B) and secure with collar rings (O).
14. Install canopy (J) to mounting plate (B) and secure with screws (C).
15. Install light bulbs into the sockets.

VISUAL COMFORT

## ASSEMBLY INSTRUCTIONS

Cord mount  
sold separately

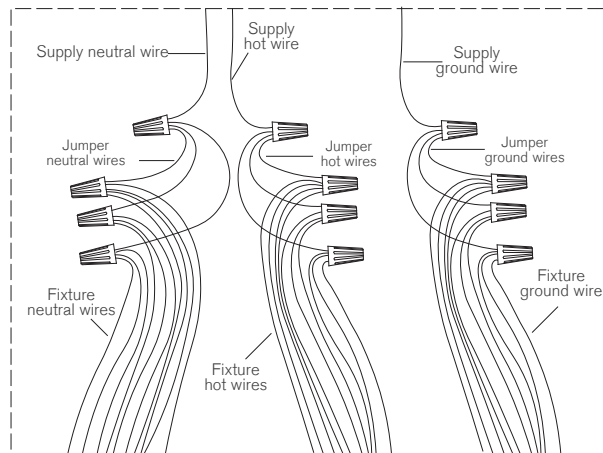
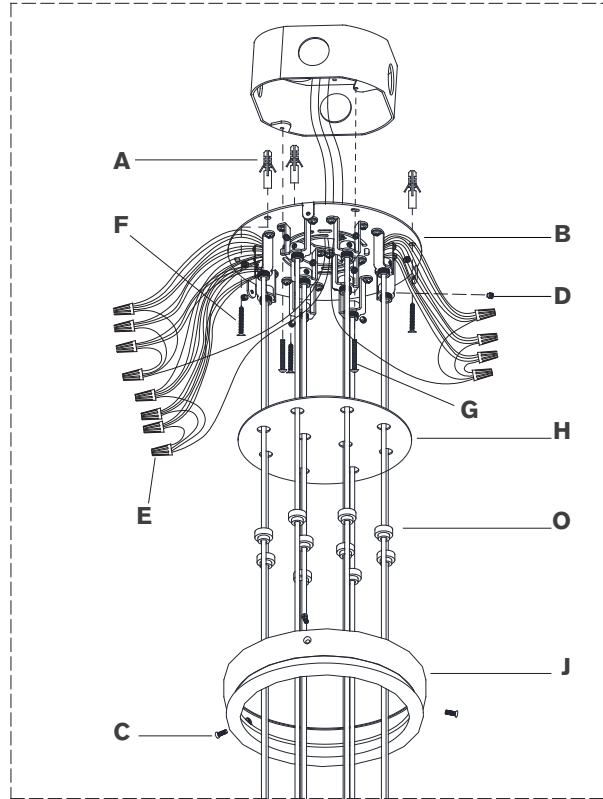
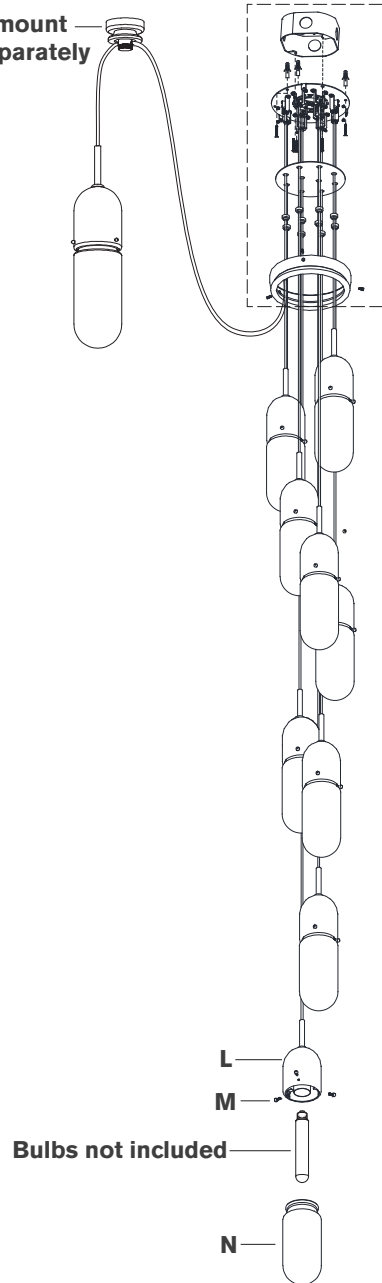

Diagram 3

## Junio 10-Light Pendant

Item # TOB5645-10

### NOTICE:

This light fixture should be installed in accordance with all applicable, local installation codes, and by a person familiar with the construction and operation of it, as well as the hazards involved. Inspect item and contents carefully. If any damage or defect is found, do not install. Retain all packaging material until installation is complete and approved.

16. Install glass shades (**N**) to fixture body (**L**) and secure with thumbscrews (**M**).

**NOTE:** Thread thumbscrews (**M**) in evenly to ensure glass is properly secured. Do not overtighten.

**Care Instructions:** Clean only with a soft dry cloth or feather duster. Do Not use abrasive or chemical agents.

VISUAL COMFORT

## ASSEMBLY INSTRUCTIONS

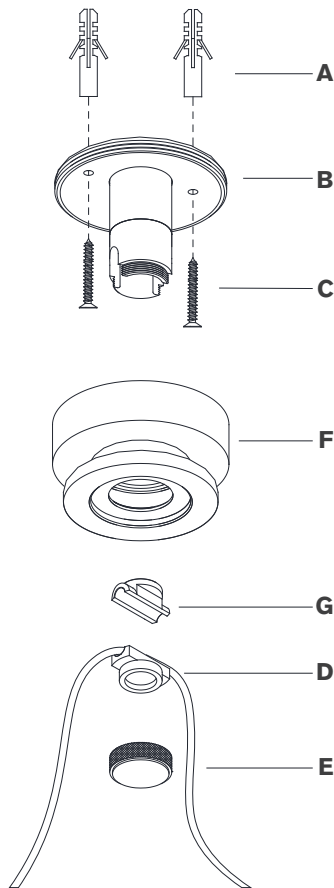

### Assembled View

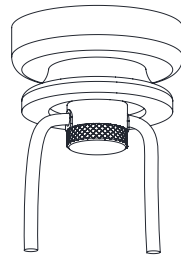

## Junio Cord Mount

Item # TOB5645-PRT

### NOTICE:

This light fixture should be installed in accordance with all applicable, local installation codes, and by a person familiar with the construction and operation of it, as well as the hazards involved. Inspect item and contents carefully. If any damage or defect is found, do not install. Retain all packaging material until installation is complete and approved.

### CORD MOUNT OPTION (SOLD SEPARATELY)

1. Carefully remove all parts from the box. Place on a clean, soft surface.
2. Remove canopy (F) from mounting plate (B) by unscrewing, then remove threaded cap (E) and wire mounts (G & D) from mounting plate.
3. Using the mounting plate (B) as a guide, line up with ceiling and mark anchor positions.
4. Using a drill bit slightly smaller than the anchor, drill holes in the marked positions. Install anchors (A) into the holes using hammer.
5. Install mounting plate (B) to ceiling and secure with wood screws (C) to anchors (A).
6. Thread canopy (F) to mounting plate (B).
7. Place fixture wire into slot of bottom wire mount (D).
8. Adjust fixture wire to desired height, then install wire mounts (G & D) to mounting plate (B) and secure with threaded cap (E).

**Care Instructions:** Clean only with a soft dry cloth or feather duster. Do Not use abrasive or chemical agents.